

# DOWNLIGHTERS

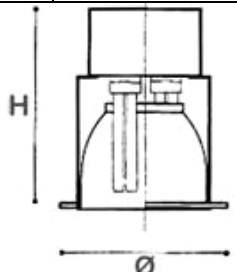



# Lampes verticales

# HL 510

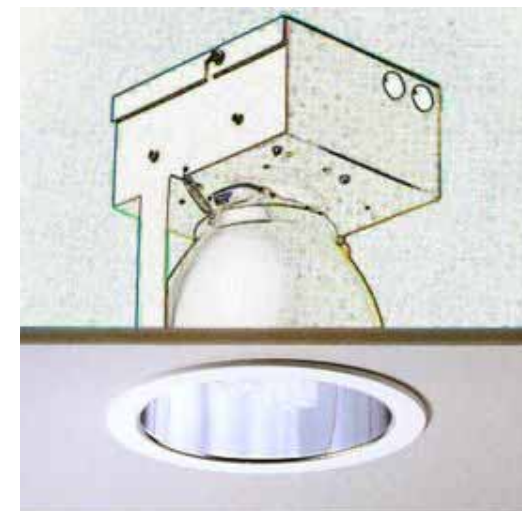
G24d-1	2x13 W		<ul style="list-style-type: none"> <li>➤ Excellente photométrie</li> <li>➤ Rendement élevé</li> <li>➤ Réflecteur aluminium extra pur</li> <li>➤ Fixation au plafond par 4 ressorts</li> <li>➤ Lampes verticales</li> </ul>
G24d-2	2x18 W		
G24d-3	3x13 W		
230 V	3x18 W		
	2x26W		





RAL

Code	Désignation	U service		Culot	Dimensions mm			U.R.
		V	W		H	Ø		
510001.xy	HL 510 2x13W	230	2x13	G24d-1	215	188		1
510002.xy	HL 510 2x18W	230	2x18	G24d-2	215	188		1
510003.xy	HL 510 3x13W	230	3x13	G24d-1	215	188	175	1
510004.xy	HL 510 3x18W	230	3x18	G24d-2	215	188		1
510005.xy	HL 510 2x26W (1)	230	2x26	G24d-3	200	188		1

(1) Coffret d'alimentation séparé

### EQUIPEMENTS AUXILIAIRES



VERRE SABLE



VERRE TRANSPARENT

- x = 0 > blanc
- x = 1 > noir
- x = 2 > chrome
- x = 3 > or

x = COLLERETTE

- y = 1 > or lisse
- y = 2 > argent lisse
- y = 3 > or satiné
- y = 4 > argent satiné

y = REFLECTEUR



Héliophane sarl

Le Prieuré  
2, rue de la mairie  
F88600 AYDOILLES

4, montée de Voulat  
F42000 SAINT ETIENNE



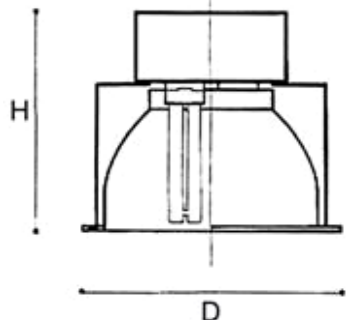

[courrier@heliophane.com](mailto:courrier@heliophane.com)

APPAREILLAGE

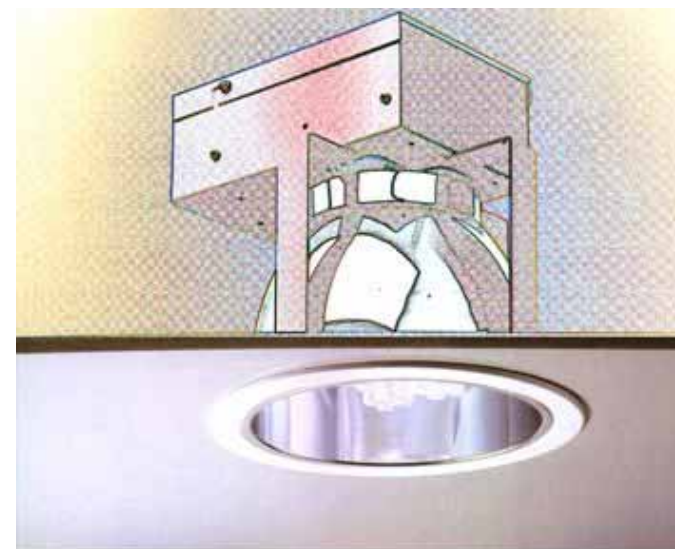
G24d-1	2x13 W 2x18 W 2x26 W		<ul style="list-style-type: none"> <li>➤ Excellente photométrie</li> <li>➤ Réflecteur aluminium extra pur</li> <li>➤ <u>Rendement élevé</u></li> <li>➤ Lampes verticales</li> <li>➤ <u>Coffret d'alimentation séparé</u></li> </ul>
G24d-2			
G24d-3			
230 V			<ul style="list-style-type: none"> <li>➤ Alim. Conventionnelle</li> <li>➤ Alim. Électronique non graduable</li> <li>➤ Alim. électronique graduable</li> </ul>
			



 IP 20 850 °C 

RAL

Code	Désignation	U service	P	Culot	Dimensions			U.R.
					V	W	H	
513001.xy	HL 513 2x13	230	2x13	G24d-1	215	230		1
513001.xy	HL 513 2x18	230	2x18	G24d-2	215	230	215 / 220	1
513001.xy	HL 513 2x26	230	2x26	G24d-3	215	230		1

EQUIPEMENTS AUXILIAIRES



VERRE SABLE



VERRE TRANSPARENT

- x = 0 > blanc
- x = 1 > noir
- x = 2 > chrome
- x = 3 > or
- x = COLLERETTE
- y = 1 > or lisse
- y = 2 > argent lisse
- y = 3 > or satiné
- y = 4 > argent satiné
- y = REFLECTEUR



Le Prieuré  
2, rue de la mairie  
F88600 AYDOILLES

Héliophane sarl

4, montée de Vourlat  
F42000 SAINT ETIENNE

  
[courrier@heliophane.com](mailto:courrier@heliophane.com)

APPAREILLAGE



# DOWNLIGHTERS

# Lampes verticales

HL 514

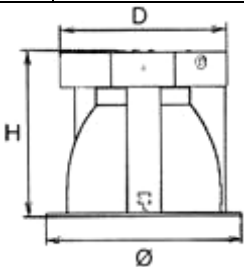
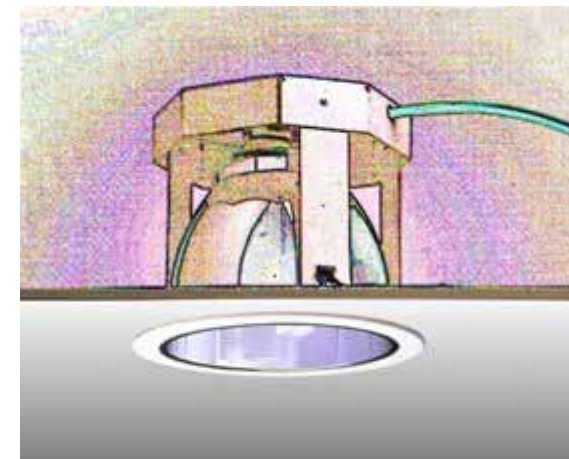
G24d-3 Gx24q-3	2x18 W 2x26 W		<ul style="list-style-type: none"> <li>➤ Excellente photométrie</li> <li>➤ Réflecteur aluminium extra pur</li> <li>➤ <u>Rendement élevé</u></li> <li>➤ Lampes verticales</li> <li>➤ <u>Coffret d'alimentation séparé</u></li> </ul>
230 V			

 IP 20 850 °C 

RAL

Code	Désignation	U service	P	Culot	Dimensions mm		U.R.
					H	D	
514001.xy	HL 514218 xy	230	2x18	G24d-2	196	195	1
514002.xy	HL 514218 xy ELECTRONIQUE	230	2x18	G24q-2	196	195	1
514003.xy	HL 514218 xy ELECTRONIQUE GRADABLE	230	2x18	G24q-2	196	195	1
514004.xy	HL 514226 xy	230	2x26	G24d-3	196	195	
514005.xy	HL 514226 xy ELECTRONIQUE	230	2x26	G24q-3	196	195	
514006.xy	HL 514226 xy ELECTRONIQUE GRADABLE	230	2x26	G24q-3	196	195	

### EQUIPEMENTS AUXILIAIRES

- x = 0 > blanc
- x = 1 > noir
- x = 2 > chrome
- x = 3 > or
- x = COLLERETTE
- y = 1 > or lisse
- y = 2 > argent lisse
- y = 3 > or satiné
- y = 4 > argent satiné
- y = REFLECTEUR
- z = F > ferromagnétique
- z = E > électronique
- z = EG > électronique gradable



VERRE DÉCORATIFS

VERRE	
Sablé	
Transparent	Centre
	Labyrinthe
	Pointillés
	Incolore Bleu Vert



Le Prieuré  
2, rue de la mairie  
F88600 AYDOILLES

Héliophane sarl

4, montée de Vourlat  
F42000 SAINT ETIENNE



[courrier@heliophane.com](mailto:courrier@heliophane.com)

APPAREILLAGE

# DOWNLIGHTERS

# Lampes verticales

HL 516

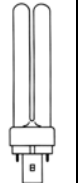
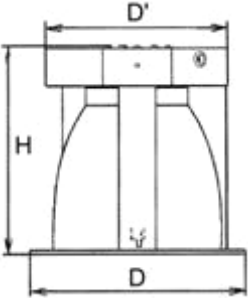
G24d-3 Gx24q-3	2x32 W 2x42 W 3x26 W			<ul style="list-style-type: none"> <li>➤ Excellente photométrie</li> <li>➤ Réflecteur aluminium extra pur à facettes géométriques</li> <li>➤ <u>Rendement élevé</u></li> <li>➤ Lampes verticales</li> <li>➤ Coffret d'alimentation séparé</li> <li>➤ Alimentation conventionnelle, électronique ou électronique graduable</li> </ul>
230 V				

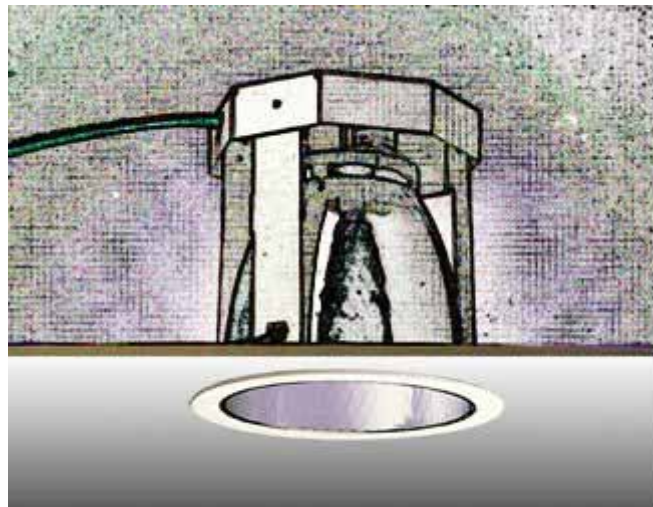

 IP 20 850 °C 

RAL

Code	Désignation	U service		Culot	Dimensions mm				U.R.
		V	W		H	D		D'	
516001 xyz	HL 514 3x26W	230	3x26	G24d-3	227	230		195	1
516002 xyz	HL 514 2x32W	230	2x32	Gx24q-3	227	230	215/ 220	195	1
516003 xyz	HL 514 2x42W	230	2x42	Gx24q-3	227	230		195	1

### EQUIPEMENTS AUXILIAIRES



VERRE DÉCORATIFS

- x = 0 > blanc
- x = 1 > noir
- x = 2 > chrome
- x = 3 > or
- x = COLLERETTE
- y = 1 > or lisse
- y = 2 > argent lisse
- y = 3 > or satiné
- y = 4 > argent satiné
- y = REFLECTEUR
- z = F > ferromagnétique
- z = E > électronique
- z = EG > électronique graduable

VERRE		
Transparent	Sablé	
	Centre	Incolore
	Labyrinthe	Bleu
	Pointillés	Vert



Le Prieuré  
2, rue de la mairie  
F88600 AYDOILLES

Héliophane sarl

4, montée de Voulat  
F42000 SAINT ETIENNE



[courrier@heliophane.com](mailto:courrier@heliophane.com)

APPAREILLAGE



# DOWNLIGHTERS

# Lampes verticales

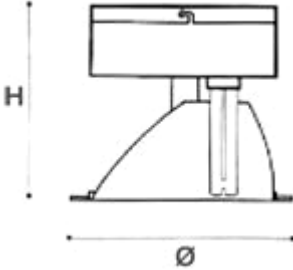

HL 519

G24d-2	2x18 W		<ul style="list-style-type: none"> <li>➤ Réflecteur à facettes en aluminium satiné</li> <li>➤ Photométrie asymétrique</li> <li>➤ Effet « lèche mur »</li> </ul>
G24d-3	1x26 W		
230 V	2x26 W		

 IP 20 850 °C 

RAL

Code	Désignation	U service		P	Culot	Dimensions mm			U.R.
		V	W			H	Ø		
519001.xy	ENA 3101 2x18W	230	1x26	G24d-2	205	230	215 / 220		1
519002.xy	ENA 3101 1x26W	230	2x18	G24d-3	205	230			1
519003.xy	ENA 3101 2x26W	230	2x26	G24d-3	205	230			1

(1) Coffret d'alimentation séparé

EQUIPEMENTS AUXILIAIRES



VERRE SABLE



VERRE TRANSPARENT

x = 0 > blanc  
 x = 1 > noir  
 x = 2 > chrome  
 x = 3 > or

x = COLLERETTE

y = 1 > or lisse  
 y = 2 > argent lisse  
 y = 3 > or satiné  
 y = 4 > argent satiné

y = REFLECTEUR

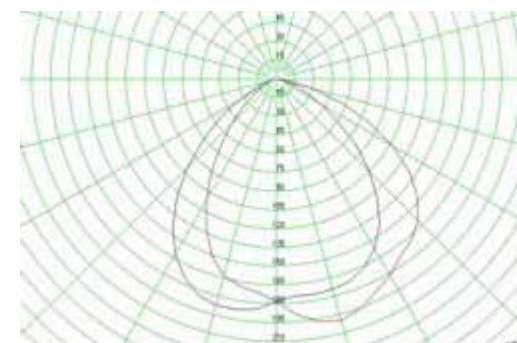

Héliophane sarl

Le Prieuré  
 2, rue de la mairie  
 F88600 AYDOILLES

4, montée de Vourlat  
 F42000 SAINT ETIENNE



[courrier@heliophane.com](mailto:courrier@heliophane.com)

APPAREILLAGE